

ESTEAM CLEANING SYSTEMS

NINJA 150 MODELS

OWNER'S MANUAL

Congratulations on your selection of a new Ninja soil extractor built in Canada by "Esteam Cleaning Systems." Our goal has been to produce the best high performance line of carpet cleaning equipment on the market today. Reading your owners manual will help to achieve maximum benefit from your purchase.



760-016

TABLE OF CONTENTS

	Page No.
Introduction on the Ninja 150	2
Specifications	2
Maintenance	3
Safety Information	3
Operating Instructions	4
Trouble Shooting	7
Schematic	10
Circuit Indicator Option	27
Warranty Registration	33
Warranty	34

INTRODUCTION

Be it a small residential job or a large commercial contract, Esteam Cleaning Systems industrial carpet cleaning extractors are right for your needs. The Ninja 150 delivers the ultimate in power, capacity, durability, and performance. The Ninja 150 is a light weight portable electronic truckmount, and is one of the most powerful soil extractors on the market.

Only the highest quality components go into our equipment, to deliver you strength and reliability in a long life high performance machine. All Esteam Cleaning Systems equipment housings are made of high impact, unbreakable polyethylene.

The Ninja 150 incorporates a dual 2 stage vacuum producing 150 inches of water lift or 185 inches of water lift with optional dual 3 stage vacuums.

SPECIFICATIONS NINJA 150

	<i>NJA150 NJA150-20</i>	<i>NJA150-05 NJA150-20-05</i>	<i>NJA150-10 NJA150-20-10</i>
<i>ELECTRICAL</i> Amps Volts	One cord 15 amps 115 volts(220volts)	Two cords 15 amps per cord 115 volts(220volts)	Two cords 15 amps per cord 115 volts(220volts)
<i>VACUUM MOTOR</i> Cfm's Vacuum lift	2-2 stage 94 150"	2-3 stage High Performance 101 185"	2-2 stage 94 150"
<i>PUMP</i>	150 psi	150 psi	150 psi
<i>INTERNAL HEATER</i>	N/A	N/A	1850 watt / 200°F
<i>SOLUTION TANK</i> (Clean water)	10.5 gallons (40 litres)	10.5 gallons (40 litres)	10.5 gallons (40 litres)
<i>RECOVERY TANK</i>	10.5 gallons (40 litres)	10.5 gallons (40 litres)	10.5 gallons (40 litres)
<i>LENGHT</i>	26 inches (66 cm)	26 inches (66 cm)	26 inches (66 cm)
<i>WIDTH</i>	17 inches (43 cm)	17 inches (43 cm)	17 inches (43 cm)
<i>HEIGHT</i>	34 inches (86 cm)	34 inches (86 cm)	34 inches (86 cm)
<i>WEIGHT</i>	110 lbs (49.8 kgs)	115 lbs (52 kgs)	115 lbs (52 kgs)

MAINTENANCE

DAILY:

- Clean high water level float screen inside the recovery tank.
- Ensure high level float ball is working properly.
- Rinse out recovery tank after use.
- Clean dirt and obstructions from the (recovery tank) drain valve rubber gaskets to prevent premature wear.
- Rinse out pump with clean water at conclusion of work day.
- Clean poly housing with mild soap and water.

MONTHLY:

- Clean air inlet and check exhaust port.
- Check 1 ½ dump valve seal.

YEARLY:

- We recommend that your unit be inspected by a qualified service technician once a year.

PREVENTATIVE MAINTENANCE:

- Never store this unit in a place where there is a possibility of the temperature dropping below 0°C (32°F).

SAFETY INFORMATION

1. Prior to inspection or repair of this machine, disconnect all electrical cords rendering the machine powerless. Failure to do so could result in serious or fatal injury.
2. Inspect unit daily for worn or damaged components. E.g. frayed cord, loose plug, or a plug with missing ground pin, etc.
3. This unit should only be operated when in an upright position on a level surface.
4. Do not operate unit unless it is properly grounded in a 3 pin grounded outlet. Never bend or remove ground pin from plugs.
5. Ensure filters and screens are free from lint or dirt.
6. Do not run unit if vacuum motor or pump are wet. Allow sufficient time for motor to dry before plugging unit in.
7. Do not use solvent based cleaning products in this extractor.

8. Keep air inlets and exhaust ports free from obstructions. Blocked air inlets or exhaust ports can cause the unit to overheat.
9. Do not use solution or recovery tanks for storing hoses, cords or accessories.
10. When using electrical equipment around water it is important to wear rubber soled shoes and keep machine properly grounded at all times. Failure to do so could result in a fatal electric shock.

OPERATING INSTRUCTIONS

1. Insert electrical cords into 3 pin grounded outlets. Two cord machines maybe equipped with the **Optional** Circuit Indicator located above the Switch Plate. The electrical cords must be plugged into separate circuits. When this is achieved the green light will illuminate showing the machine is ready for operation.
2. We recommend the use of a Esteam liquid Defoamer, to prevent the machine from prematurely shutting off due to excess foam in the recovery tank. Turn on vacuum and pour approximately ¼ cup of Esteam Liquid Defoamer into the end of the vacuum hose.
3. 150 PSI pump priming instructions: **Using Primer Quick Connect**
 - Fill fresh water tank
 - Attach vacuum and solution hose to machine
 - Attach primer quick connect to end of solution hose
 - Place solution hose with primer quick connect into open end of vacuum hose and hold
 - turn vacuum and pump switches on
 - Once a continuous flow of water is entering the vacuum hose, this indicates pump is primed
 - Turn off vacuum and pump switches and disconnect primer quick connect
 - Connect solution hose and vacuum hose to carpet wand
 - Turn vacuum and pump switches on
 - Machine is ready to use.

TO USE YOUR NINJA HEATER:

- A. Hook the wand solution hose to the quick connect of your machine.

- B. Plug the heater power cord into a wall that is on a separate circuit from the other cord.
- C. Turn the heater switch on.
- D. When the red light goes out, solution is heated and ready to use.

OPERATING INSTRUCTIONS (CONTINUED)

WARNING: If your heater does not work DO NOT attempt to repair it yourself, call your distributor for repair procedures. Using solvents in heaters can be hazardous and will

void your warranty. Allowing heaters to freeze will crack the heater cartridge and will also void your warranty.

DANGER: No solvents of any type may be used in this system at any time. The use of solvents is extremely hazardous resulting in possible fire and/or explosion.

4. Connect vacuum and solution hoses to the carpet cleaning wand.
5. Proceed to clean carpets.
6. When the recovery tank becomes full, vacuum will automatically stop extracting. When vacuum stops extracting it will make a distinctive high pitched noise as all the air flow will be cut off. At this time switch unit off. Drain the recovery tank by pulling up on drain valve on front of machine.

NOTE: Ensure that the high water level float screen inside the recovery tank is free from any obstructions. Be sure to close drain valve before resuming cleaning.

7. To empty solution tank remove vacuum hose from wand. Turn on vacuum and extract solution from solution tank into recovery tank, then drain recovery tank.

NOTE: Do not completely submerge end of vacuum hose into solution. Allow some air to enter end of vacuum hose with liquid.

8. When the job is completed empty and rinse out the solution and recovery tanks. Allow vacuum to run for 3 to 5 minutes. This will eliminate all moisture from vacuum assuring long vacuum life.

WARNING: When using electrical equipment around water it is important to wear rubber soled shoes and keep machine properly grounded at all times. Failure to do so could result in electric shock.

NINJA 150 MODELS



MODEL 150PSI 2-2 STAGE VAC &
MODEL 150PSI 2-3 STAGE VAC

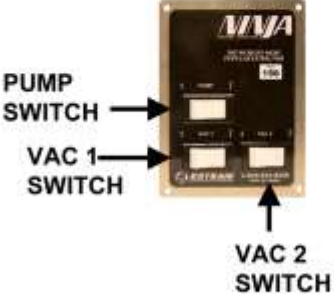

MODEL 150 HM

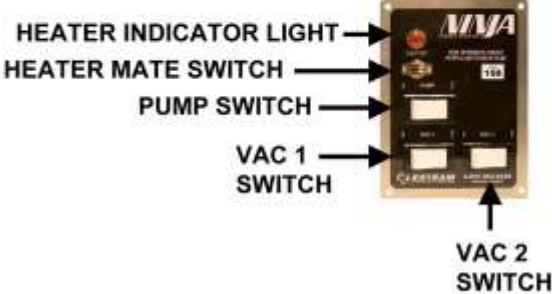

TROUBLE SHOOTING

WARNING: Prior to inspection or repair of this machine, disconnect all electrical cords rendering the machine powerless. Failure to do so could result in serious or fatal injury.

PROBLEM	CAUSE	SOLUTION
1. Entire unit will not operate	1. Unit not plugged in	1. Connect unit to 3 pin grounded outlets
	2. Loose wiring	2. See dealer
2. Pump will not run	1. Switch not turned on	1. Turn on switch
	2. Broken switch	2. See dealer
	3. Loose wiring	3. See dealer
	4. Pump motor defective	4. See dealer
3. Vacuum will not run	1. Switch not turned on	1. Turn on switch
	2. Broken switch	2. See dealer
	3. Loose wiring	3. See dealer
	4. Blocked rotor	4. See dealer
4. Pump runs but does not pump solution	1. Out of solution	1. Fill solution tank
	2. Pump inlet screen plugged	2. Clean inlet screen
	3. Pump was not properly primed	3. Prime pump using priming quick connect
	4. Kink in solution hose	4. Remove kink
	5. Plugged jet or quick connect	5. Remove blockage
	6. Internal (inside machine) or external solution line damaged and leaking	6. See dealer
5. Pump runs but has loss pressure	1. Partial kink in solution hose	1. Remove kink
	2. Partial blockage in solution hose	2. Remove blockage
	3. Jet orifice opening on cleaning wand is too large	3. Total jet opening for 150 PSI pump should be .06 or .08. Heat option should be .03

PROBLEM	CAUSE	SOLUTION
6. Vacuum operates but has poor or no suction	1. Recovery tank full	1. Drain recovery tank
	2 Vacuum hose plugged	2. Locate and remove blockage
	3. Wand plugged	3. Locate and remove blockage
	4. Exhaust port blocked	4. Locate and remove blockage
	5. High level float stuck in off position	5. Turn vacuum off and tap top of float screen cage
	6. Front drain valve left open after draining recovery tank	6. Close recovery tank drain valve on front of machine
7. Vacuum prematurely stops extracting	1. Excess foam in recovery tank	1. Add defoamer to recovery tank
	2. Lint or dirt on automatic shut off float screen	2. Clean auto shut off float screen
	3. Defective float ball	3. Replace float screen cage
8. Machine spits water out of exhaust port	1. High level float not working properly	1. Check auto shut off float cage and ball for proper operation
9. Machine blowing excessive amounts of water out of exhaust ports	1. Damaged (leaking) recovery tank fittings	1. Immediately shut unit down. Bring unit to a dealer for service
10. Water accumulating in bottom electrical component area	1. Inside solution line leaking	1. Immediately shut unit down. Bring unit to a dealer for service
	2. Pump leaking	2. Immediately shut unit down. Bring unit to a dealer for service
	3. Solution or recovery tank leaking from above	3. Immediately shut unit down. Bring to a dealer for service
11. Heater won't work	1. Heater cord not plugged in	1. Connect cord to 3 Pin (separate) outlet
	2. Faulty Thermostat or Thermo cut-out	2. See dealer
12. Water not hot enough	1. Check Jet size on wand or upholstery tool	1. Do not exceed .03 orifice size for maximum heat transfer
	2. Cold water used in solution tank	2. Use hot tap water for maximum heat transfer

NINJA 150 PSI

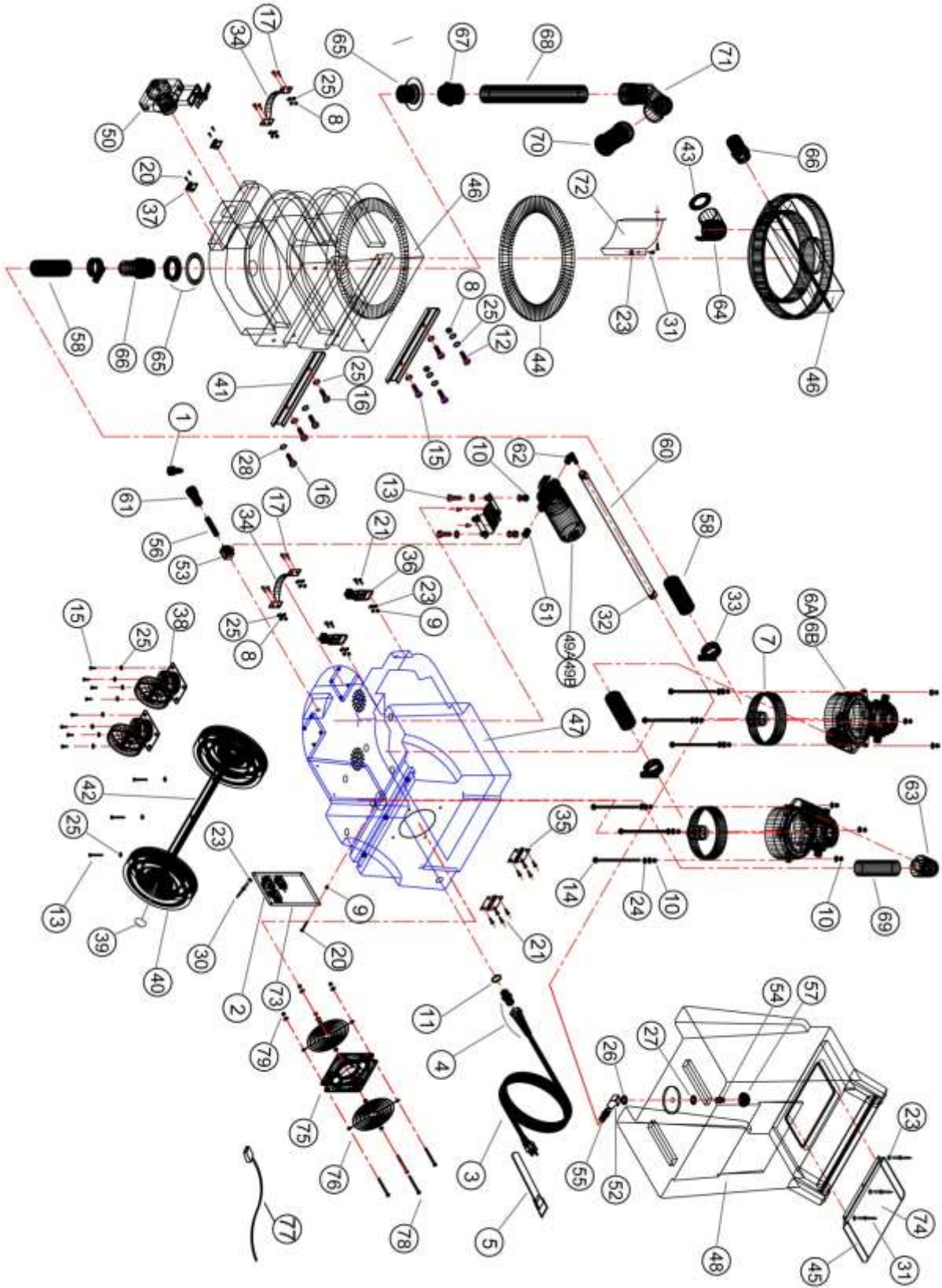

NINJA 150 PSI (P. 1)

REF	PART NO.	DESCRIPTION	NOTES:
1	580-015	1/4 Quick Connect (For priming pump)	
2	305-230	Switch, Rocker 20 Amp	
3	315-015	Cord, 25' Black 14/3 SJTW-A	
4	335-005	Strain Relief, 12 Gauge	
5	350-005	Strap Velcro	
6A	355-401	Vacuum, 2 Stg - 110v (C/W: 355-405)	NJA150
6B	355-500	Vacuum, 2 Stg - 220v	NJA150-20
7	355-405	Vacuum Cap, Straight	
8	400-115	Locknut, 1/4 x 20 Nylon SS	
9	400-130	Locknut, 10 x 24 Nylon SS	
10	400-135	Locknut, 1/4 x 20 Nylon Zinc	
11	400-165	Locknut, 1/2"	
12	405-010	Bolt, 1/4 x 1 SS	
13	405-020	Bolt, 1/4 x 1-1/4 SS	
14	405-065	Bolt, 1/4 x 6 Stove Zinc	
15	405-615	CS, 1/4 x 1/2 SS (Hex HD)	
16	405-620	CS, 1/4 x 3/4 SS (Hex HD)	
17	410-005	MS, 1/4 x 1 Phil SS Flat/H	
18	410-058	SMS, 4 x 1/4 Pan Phil S.S.	Not shown
19	410-125	SMS, 8 x 5/8 Pan Rob. S.S.	Not shown
20	410-160	MS, 10-24 x 3/4 Pan PH SS	
21	410-205	MS, 10-32 x 1/2 Panphil SS	
22	410-225	SMS, 10 X 1/2 Pan Rob. Zinc	Not shown
23	415-115	FW, 10 SS	
24	415-120	FW, 1/4 Zinc	
25	415-125	FW, 1/4 SS	
26	415-155	FW, 1/2 SS (Stand/Max OD)	
27	415-156	FW, 1/2 SS	
28	415-305	FNDW, 1/4 SS	
29	420-055	Rivet, AL/AL #46	Not shown
30	420-105	Rivet, AL/ST #66	
31	420-151	Rivet, AL/AL Fully sealed #68	
32	425-005	Clamp, #8 Hose 1/2 x 1	
33	425-010	Clamp, #20 Hose 13/16 x 1 3/4	
34	435-015	Handle, Brass/Chrome	
35	440-006	S.S. Hinge 2" x 2"	
36	445-015	Latch, Machine	
37	445-020	Latch, Striker	
38	455-075	Caster, 4" Swivel	
39	455-052	Wheel Cap Dome	
40	455-057	Wheel, 8" Grey/Black Hub	
41	465-065	Brace, Ninja Tank	
42	470-051	Axel, Ninja HD	
43	475-010	Gasket, Rubber - 1 1/2" Dump Valve	

NINJA 150 PSI (P. 2)

44	475-030	Gasket, Lid 3/8"	
45	475-040	Gasket, 1/8 x 1"	
46	495-021C	Recovery Tank & Lid Ninja	
47	495-035	Base, Ninja	
48	495-040	Sol Tank Ninja	
49A	511-105	Pump, 150 PSI (110v)	NJA150
49B	511-305	Pump, 150 PSI (220v)	NJA150-20
50	545-100	Dump Valve, 1 1/2"	
51	555-024	Bushing, 3/8 M x 1/4 FM	
52	555-182	Elbow 45, 1/4 FEM. Extruded	
53	555-208	Elbow 90, 1/4 Street Extruded	
54	555-272	Hex Nipple, 1/4" (Long)	
55	555-370	Hose Barb, 1/2 Barb x 1/4 MPT	
56	555-424	Long Nipple, 1/4 x 2 1/2"	
57	560-030	Screen, Acorn	
58	570-010	Vac Hose 1 1/2" Wire Reinforced	
59	572-041	L.P. Hose 3/8"	Not Shown
60	572-155	Polyspring Hose, 1/2"	
61	580-010	Q.C. 1/4" Fem (Closed)	
62	585-110	Nylon, 90 Barb 1/2 x 3/8 NPT	
63	590-010	PVC Elbow 1 1/4" 90, S x S	
64	590-020	PVC ELB 1 1/2" 90, S x FIPT	
65	590-205	PVC Wall Fitting, 1 1/2"	
66	590-405	PVC Hose Barb 1 1/2" x MPT	
67	590-415	PVC Adpt 1 1/2", S x MPT	
68	595-005	ABS Pipe, 1 1/2"	
69	595-110	PVC Pipe, 1 1/4"	
70	597-010	Float Screen Cage	
71	597-061	Adpt (RM) 30 Degree	
72	845-010	Baffle, S/S	
73	845-030	Switch Plate	
74	845-040	Solution Tank Cover	
75	333-015	Fan 6" 220V	
76	560-330	Finger guards	
77	315-040	Cord, Fan	
78	410-175	MS, 10-24 x 2 1/2 Zinc	
79	400-005	Lock nut 10-24 Zinc	

NINJA 150 PSI 2-3 STAGE VAC

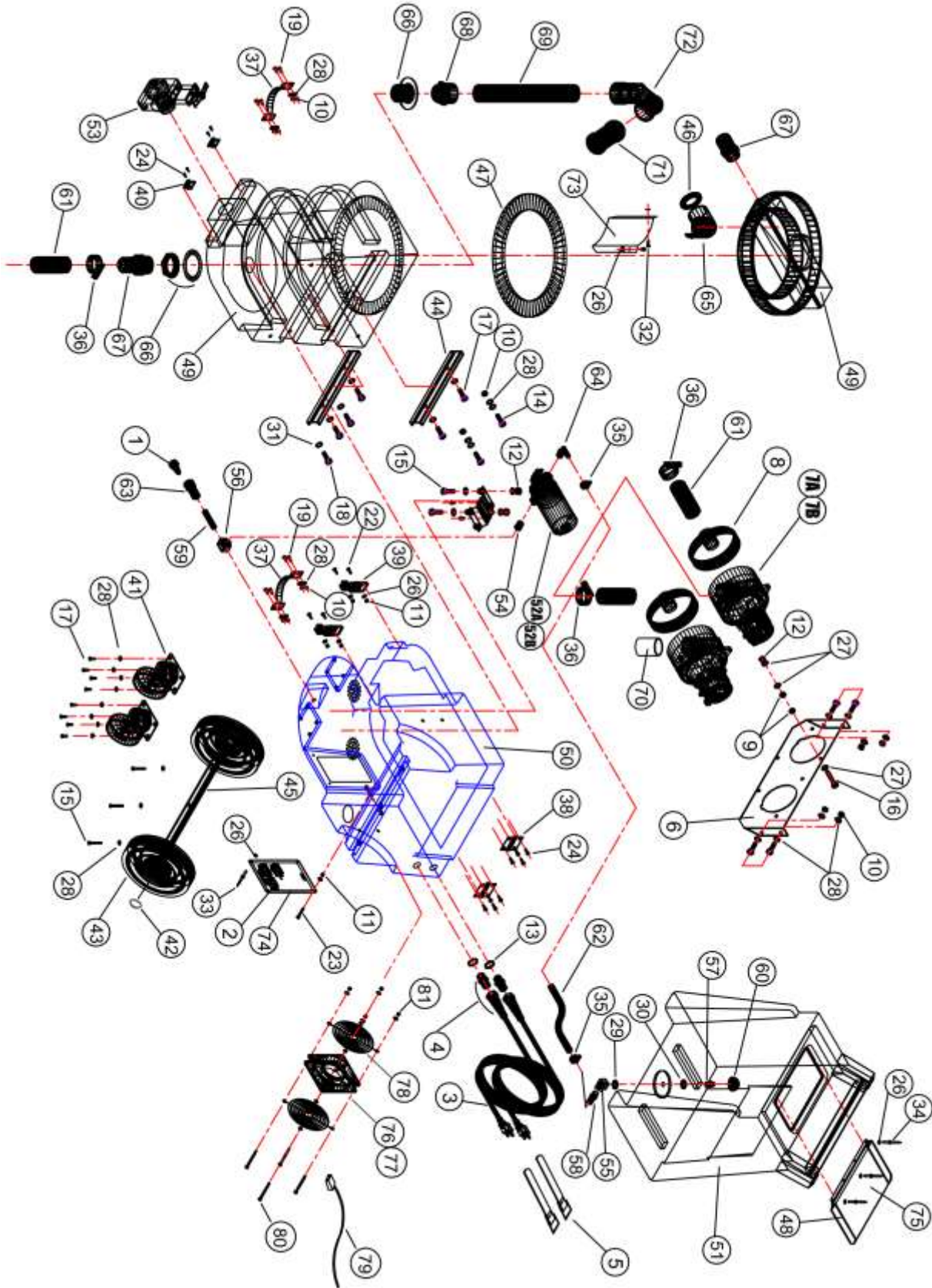

NINJA 150 PSI 2-3 STAGE VAC (P. 1)

REF	PART NO.	DESCRIPTION	NOTES:
1	580-015	1/4 Quick Connect (For priming pump)	
2	305-230	Switch, Rocker 20 Amp	
3	315-015	Cord, 25' Black 14/3 SJTW-A	
4	335-005	Strain Relief, 12 Gauge	
5	350-005	Strap Velcro	
6	355-005	BRKT, Vac 3-Stage	
7A	355-411	Vacuum, 3 Stg - 110v (C/W: 355-405)	NJA150-05
7B	355-510	Vacuum, 3 Stg - 220v	NJA150-20-05
8	355-405	Vacuum Cap, Straight	
9	400-010	Hex Nut, 1/4 x 20 Zinc	
10	400-115	Locknut, 1/4 x 20 Nylon SS	
11	400-130	Locknut, 10 x 24 Nylon SS	
12	400-135	Locknut, 1/4 x 20 Nylon Zinc	
13	400-165	Locknut, 1/2"	
14	405-010	Bolt, 1/4 x 1 SS	
15	405-020	Bolt, 1/4 x 1-1/4 SS	
16	405-035	Bolt, 1/4 x 2 1/2 Stove Zinc	
17	405-615	CS, 1/4 x 1/2 SS (Hex HD)	
18	405-620	CS, 1/4 x 3/4 SS (Hex HD)	
19	410-005	MS, 1/4 x 1 Phil SS Flat/H	
20	410-058	SMS, 4 x 1/4 Pan Phil S.S.	Not shown
21	410-125	SMS, 8 x 5/8 Pan Rob. S.S.	Not shown
22	410-160	MS, 10-24 x 3/4 Pan PH SS	
23	410-165	MS, 10-24 x 1 Pan Slot SS	
24	410-205	MS, 10-32 x 1/2 Panphil SS	
25	410-225	SMS, 10 X 1/2 Pan Rob. Zinc	Not shown
26	415-115	FW, 10 SS	
27	415-120	FW, 1/4 Zinc	
28	415-125	FW, 1/4 SS	
29	415-155	FW, 1/2 SS (Stand/Max OD)	
30	415-156	FW, 1/2 SS	
31	415-305	FNDW, 1/4 SS	
32	420-055	Rivet, AL/AL #46	Not shown
33	420-105	Rivet, AL/ST #66	
34	420-151	Rivet, AL/AL Fully sealed #68	
35	425-005	Clamp, #8 Hose 1/2 x 1	
36	425-010	Clamp, #20 Hose 13/16 x 1 3/4	
37	435-015	Handle, Brass/Chrome	
38	440-006	S.S. Hinge 2" x 2"	
39	445-015	Latch, Machine	
40	445-020	Latch, Striker	
41	455-075	Caster, 4" Swivel	
42	455-052	Wheel Cap Dome	
43	455-057	Wheel, 8" Grey/Black Hub	
44	465-065	Brace, Ninja Tank	

NINJA 150 PSI 2-3 STAGE VAC (P. 2)

45	470-051	Axel, Ninja HD	
46	475-010	Gasket, Rubber - 1 1/2" Dump Valve	
47	475-030	Gasket, Lid 3/8"	
48	475-040	Gasket, 1/8 x 1"	
49	495-021C	Recovery Tank & Lid Ninja	
50	495-035	Base, Ninja	
51	495-040	Sol Tank Ninja	
52A	511-105	Pump, 150 PSI, 110v	NJA150-05
52B	511-305	Pump, 150 PSI, 220v	NJA150-20-05
53	545-100	Dump Valve, 1 1/2"	
54	555-024	Bushing, 3/8 M x 1/4 FM	
55	555-182	Elbow 45, 1/4 FEM. Extruded	
56	555-208	Elbow 90, 1/4 Street Extruded	
57	555-272	Hex Nipple, 1/4" (Long)	
58	555-370	Hose Barb, 1/2 Barb x 1/4 MPT	
59	555-424	Long Nipple, 1/4 x 2 1/2"	
60	560-030	Screen, Acorn	
61	570-010	Vac Hose 1 1/2" Wire Reinforced	
62	572-155	Polyspring Hose, 1/2"	
63	580-010	Q.C. 1/4" Fem (Closed)	
64	585-110	Nylon, 90 Barb 1/2 x 3/8 NPT	
65	590-020	PVC ELB 1 1/2" 90, S x FIPT	
66	590-205	PVC Wall Fitting, 1 1/2"	
67	590-405	PVC Hose Barb 1 1/2" x MPT	
68	590-415	PVC Adpt 1 1/2", S x MPT	
69	595-005	ABS Pipe, 1 1/2"	
70	595-110	PVC Pipe, 1 1/4"	
71	597-010	Float Screen Cage	
72	597-061	Adpt (RM) 30 Degree	
73	845-010	Baffle, S/S	
74	845-030	Switch Plate	
75	845-040	Solution Tank Cover	
76	330-010	Fan 6" 110V	
77	333-015	Fan 6" 220V	
78	560-330	Finger guards	
79	315-040	Cord, Fan	
80	410-175	MS, 10-24 x 2 1/2 Zinc	
81	400-005	Lock nut 10-24 Zinc	

NINJA 150 PSI HEATER MATE

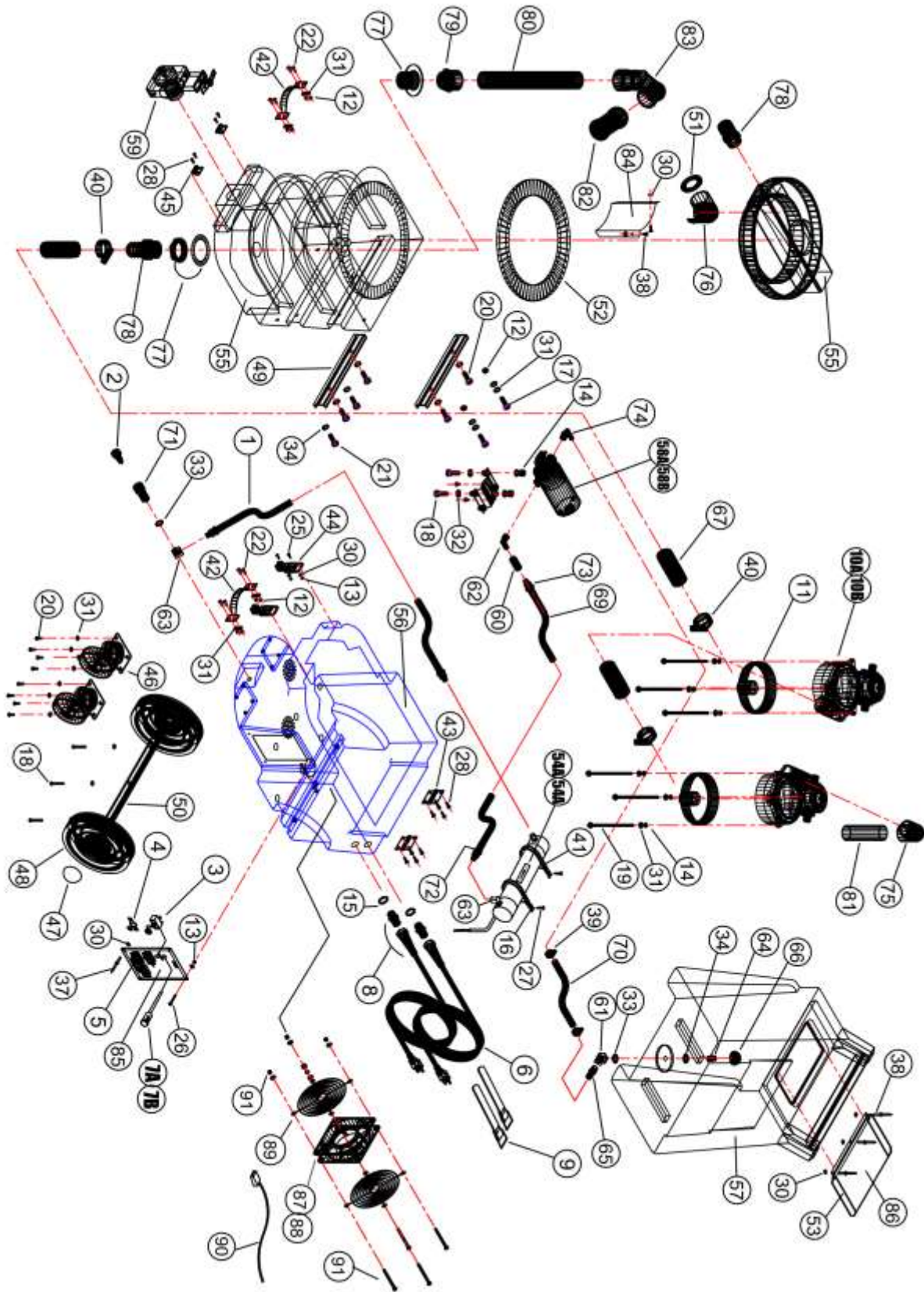

NINJA 150 PSI H.M (P. 1)

REF	PART NO.	DESCRIPTION	NOTES:
1	263-013	HP Hose 28"	
2	580-015	1/4 Quick Connect (For priming pump)	
3	305-210	Switch, Toggle 110v / 220v	
4	305-225	Switch Plate, ON/OFF	
5	305-230	Switch, Rocker 20 Amp	
6	315-015	Cord, 25' Black 14/3 SJTW-A	
7A	320-110	Lamp, Panel 110v	NJA150-10
7B	320-900	Lamp, Panel 220v	NJA150-20-10
8	335-005	Strain Relief, 12 Gauge	
9	350-005	Strap Velcro	
10A	355-401	Vacuum, 2 Stg - 110v (C/W: 355-405)	NJA150-10
10B	355-500	Vacuum, 2 Stg - 220v	NJA150-20-10
11	355-405	Vacuum Cap, Straight	
12	400-115	Locknut, 1/4 x 20 Nylon SS	
13	400-130	Locknut, 10 x 24 Nylon SS	
14	400-135	Locknut, 1/4 x 20 Nylon Zinc	
15	400-165	Locknut, 1/2"	
16	400-240	Tinnerman Nut	
17	405-010	Bolt, 1/4 x 1 SS	
18	405-020	Bolt, 1/4 x 1-1/4 SS	
19	405-065	Bolt, 1/4 x 6 Stove Zinc	
20	405-615	CS, 1/4 x 1/2 SS (Hex HD)	
21	405-620	CS, 1/4 x 3/4 SS (Hex HD)	
22	410-005	MS, 1/4 x 1 Phil SS Flat/H	
23	410-058	SMS, 4 x 1/4 Pan Phil S.S.	Not shown
24	410-125	SMS, 8 x 5/8 Pan Rob. S.S.	Not shown
25	410-160	MS, 10-24 x 3/4 Pan PH SS	
26	410-165	MS, 10-24 x 1 Pan Slot SS	
27	410-190	SMS, 10 x 1 FLT Soc Zinc	
28	410-205	MS, 10-32 x 1/2 Pan Phil SS	
29	410-225	SMS, 10 x 1/2 Pan Rob. Zinc	Not shown
30	415-115	FW, 10 SS	
31	415-120	FW, 1/4 Zinc	
32	415-125	FW, 1/4 SS	
33	415-155	FW, 1/2 SS (Stand/Max OD)	
34	415-156	FW, 1/2 SS	
35	415-305	FNDW, 1/4 SS	
36	420-055	Rivet, AL/AL #46	Not shown
37	420-105	Rivet, AL/ST #66	
38	420-151	Rivet, AL/AL Fullysealed #68	
39	425-005	Clamp, #8 Hose 1/2 x 1	
40	425-010	Clamp, #20 Hose 13/16 x 1 3/4	
41	425-130	Clamp, Tube 3"	
42	435-015	Handle, Brass/Chrome	
43	440-006	S.S. Hinge 2" x 2"	
44	445-015	Latch, Machine	
45	445-020	Latch, Striker	
46	455-075	Caster, 4" Swivel	
47	455-052	Wheel Cap Dome	
48	455-057	Wheel, 8" Grey\Black Hub	

NINJA 150 PSI H.M (P. 2)

49	465-065	Brace, Ninja Tank	
50	470-051	Axel, Ninja HD	
51	475-010	Gasket, Rubber - 1 1/2" Dump Valve	
52	475-030	Gasket, Lid 3/8"	
53	475-040	Gasket, 1/8 x 1"	
54A	490-005	Foamed Casing, Round 1850W HM	NJA150-10
54B	490-006	Foamed Casing, Round 1850W HM	NJA150-20-10
55	495-021C	Recovery Tank & Lid Ninja	
56	495-035	Base, Ninja	
57	495-040	Sol Tank Ninja	
58A	511-105	Pump, 150 PSI (110v)	NJA150-10
58B	511-305	Pump, 150 PSI (220v)	NJA150-20-10
59	545-100	Dump Valve, 1 1/2"	
60	550-035	Check Valve 1/4 FM x FM	
61	555-182	Elbow 45, 1/4 FEM. Extruded	
62	555-208	Elbow 90, 1/4 Street Extruded	
63	555-210	Elbow 90, 3/8 MPT x 1/4 MPT	
64	555-272	Hex Nipple, 1/4" (Long)	
65	555-370	Hose Barb, 1/2 Barb x 1/4 MPT	
66	560-030	Screen, Acorn	
67	570-010	Vac Hose 1 1/2" Wire Reinforced	
68	572-041	L.P Hose 3/8"	Not shown
69	572-125	Pulse Hose, 3/8"	
70	572-155	Polyspring Hose, 1/2"	
71	580-010	Q.C. 1/4" Fem (Closed)	
72	581-060	Crimp Ftng, 3/8" Pulse Hose – 1/4 MPT	
73	581-065	Crimp Ftng, 3/8" Pulse Hose 1/4 MPT SVL	
74	585-110	Nylon 90 Barb 1/2 x 3/8 NPT	
75	590-010	PVC Elbow 1 1/4" 90, S x S	
76	590-020	PVC ELB 1 1/2" 90, S x FIPT	
77	590-205	PVC Wall Fitting, 1 1/2"	
78	590-405	PVC Hose Barb 1 1/2" x MPT	
79	590-415	PVC Adpt 1 1/2", S x MPT	
80	595-005	ABS Pipe, 1 1/2"	
81	595-110	PVC Pipe, 1 1/4"	
82	597-010	Float Screen Cage	
83	597-061	Adpt (RM) 30 Degree	
84	845-010	Baffle, S/S	
85	845-030	Switch Plate	
86	845-040	Solution Tank Cover	
87	330-010	Fan 6" 110V	
88	333-015	Fan 6" 220V	
89	560-330	Finger guards	
90	315-040	Cord, Fan	
91	410-175	MS, 10-24 x 2 1/2 Zinc	
92	400-005	Lock nut 10-24 Zinc	

ESTEAM PUMP 150 PSI

ESTEAM 150 PSI PUMP KITS
511-220 UPPER HOUSING ASSY
511-230 VALVE ASSY
511-240 LOWER HOUSING ASSY
511-210 PRESSURE SWITCH

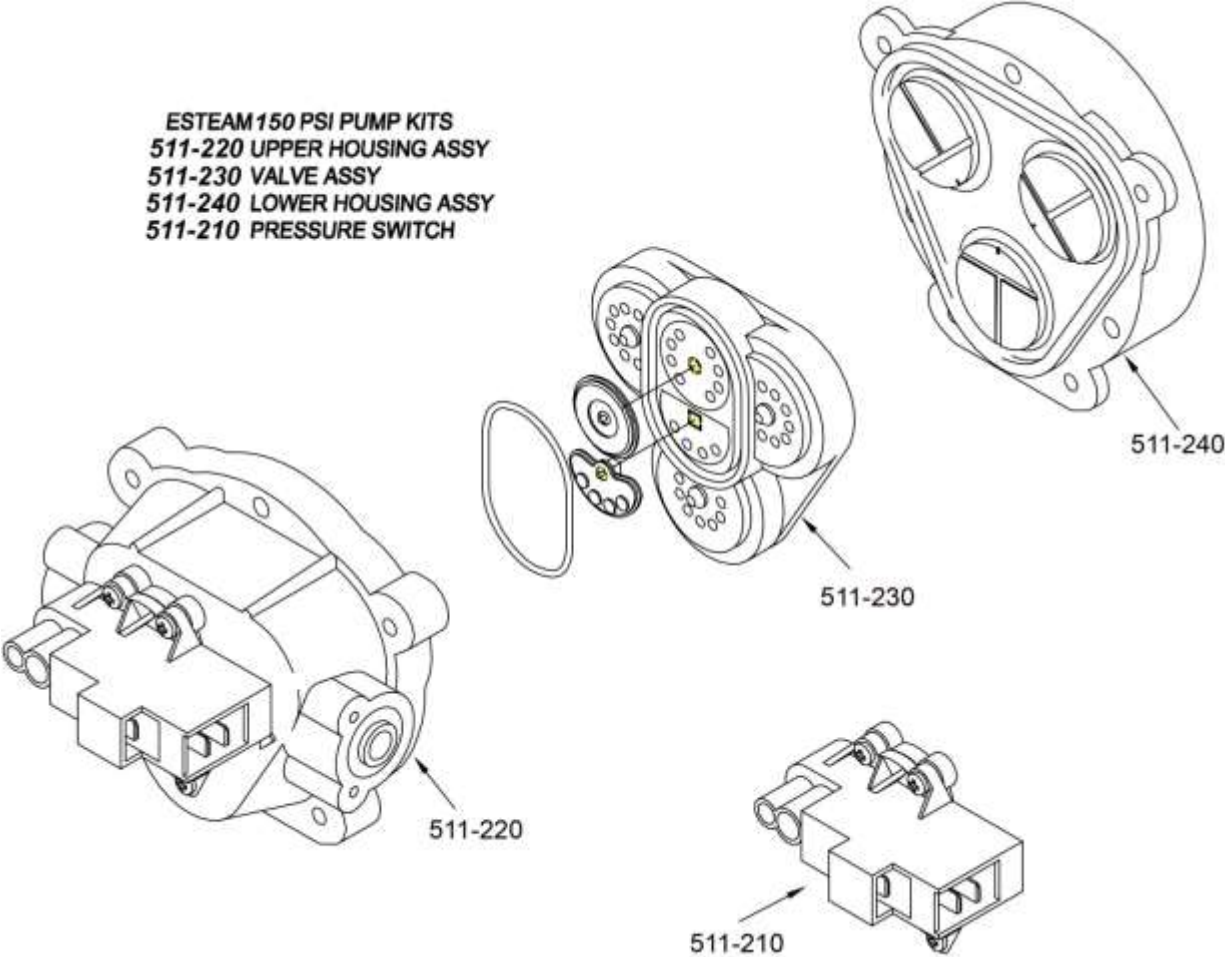

INTERNAL HEATER MATE

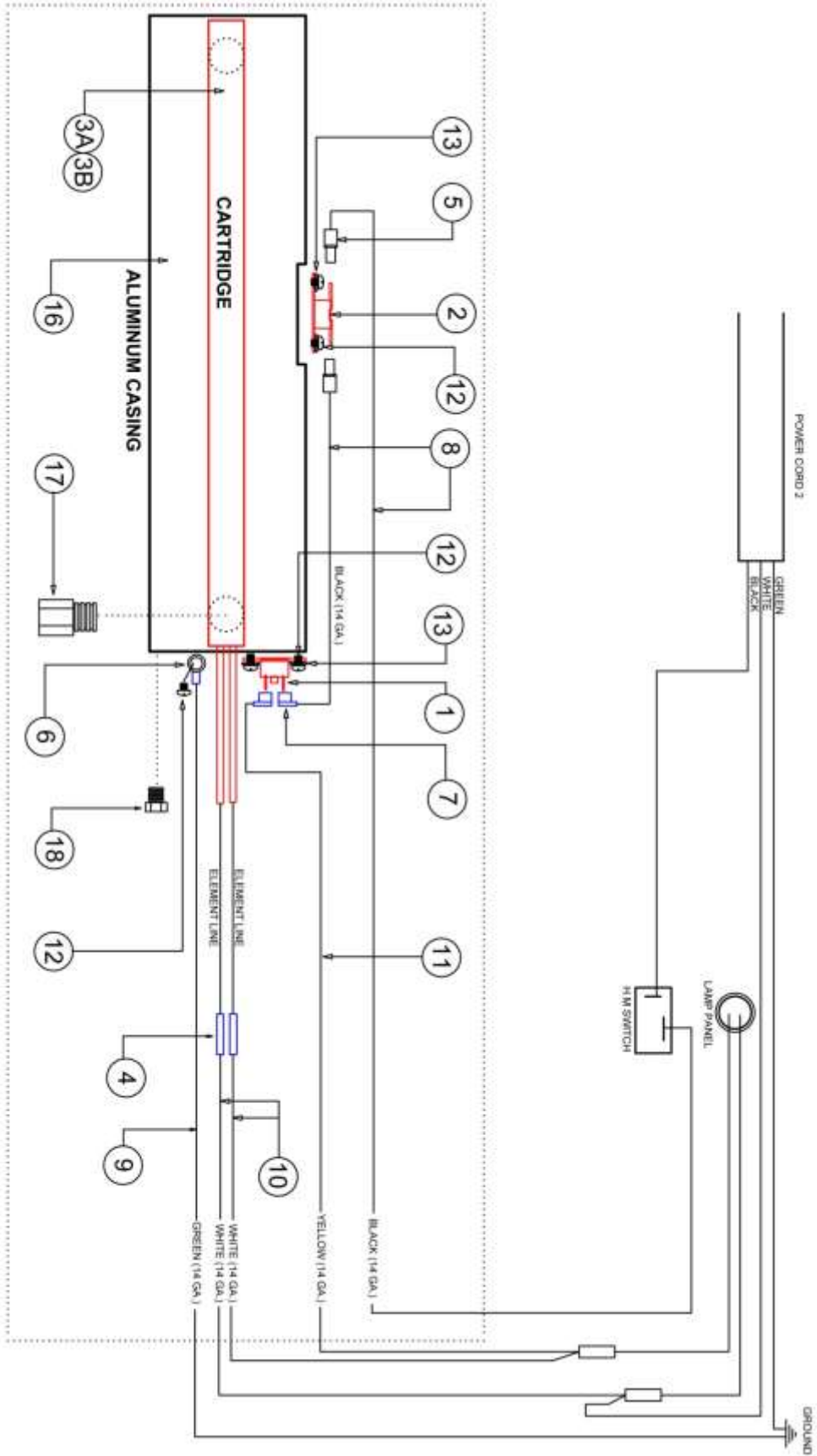

INTERNAL HEATER MATE (490-005/490-006)

REF	PART NO.	DESCRIPTION	NOTES:
1	305-245	Thermo Cut-Out	
2	305-265	Thermostat 200F	
3A	318-005	Heater Element 1850W 110V	Use For 490-005
3B	318-900	Heater Element 1850W 220V	Use For 490-006
4	325-005	Connector, Butt - Blue	
5	325-120	Spade, 3/16 F - Blue	
6	325-230	Terminal Ring, #10 - Blue	
7	325-500	Spade, 1/4 FEM. 90 Crimp	
8	330-225	Wire, 14 GA - Black	
9	330-230	Wire, 14 GA - Green	
10	330-235	Wire, 14 GA - White	
11	330-240	Wire, 14 GA - Yellow	
12	410-070	MS, 6 x 3/16 Pan PHL	
13	415-005	LW, 6 Zinc	
14	475-045	Gasket, 3" RND	Not Shown
15	475-070	Gasket 1/8"	Not shown
16	490-016	Alum (Round) Casing	
17	555-002	ADPT, 1/4 M x 1/4 F	
18	555-451	Plug, 1/8 Hex	

NINJA 150 PSI WIRING

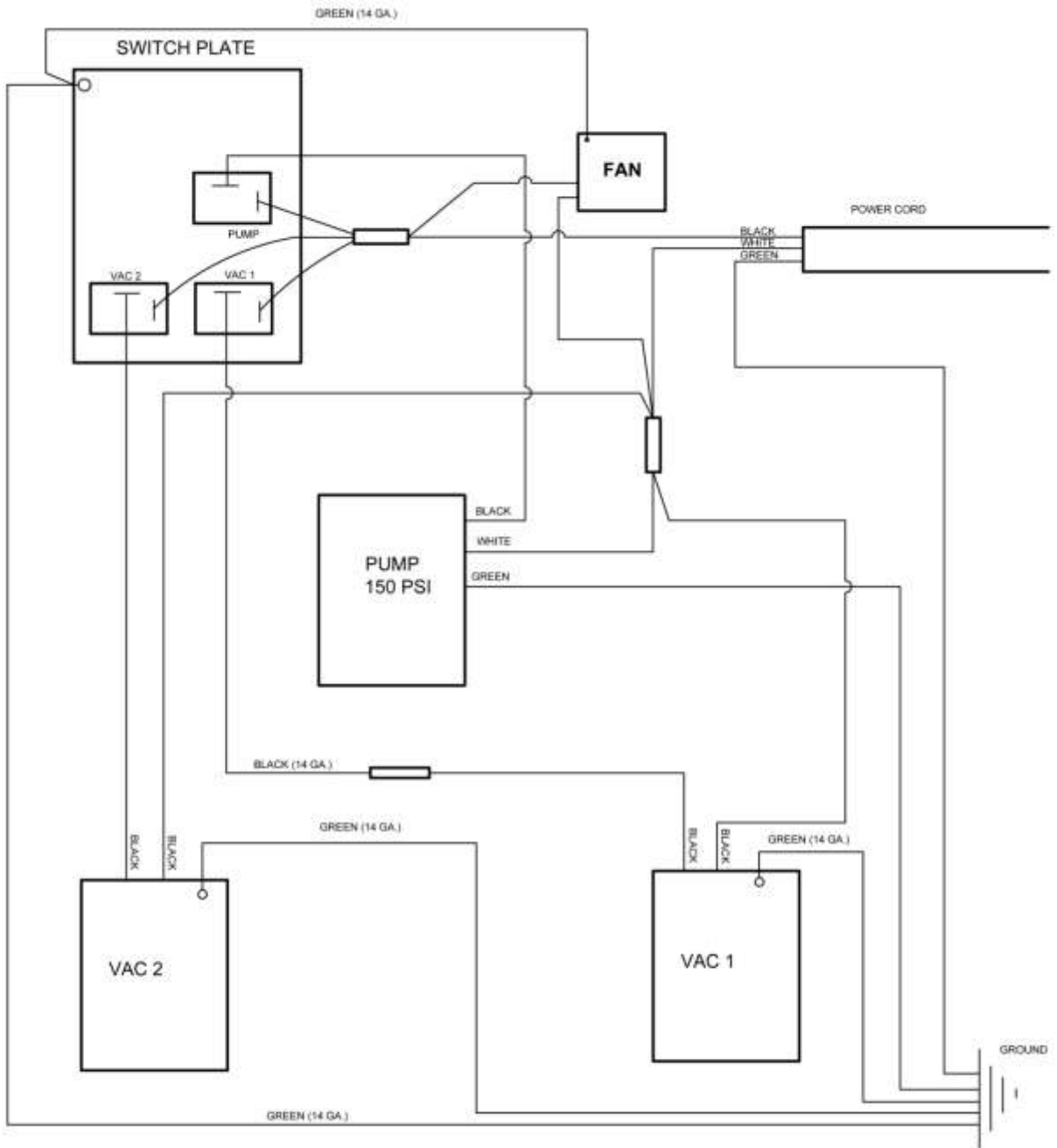

NINJA 150 PSI 2-3 STAGE VAC WIRING

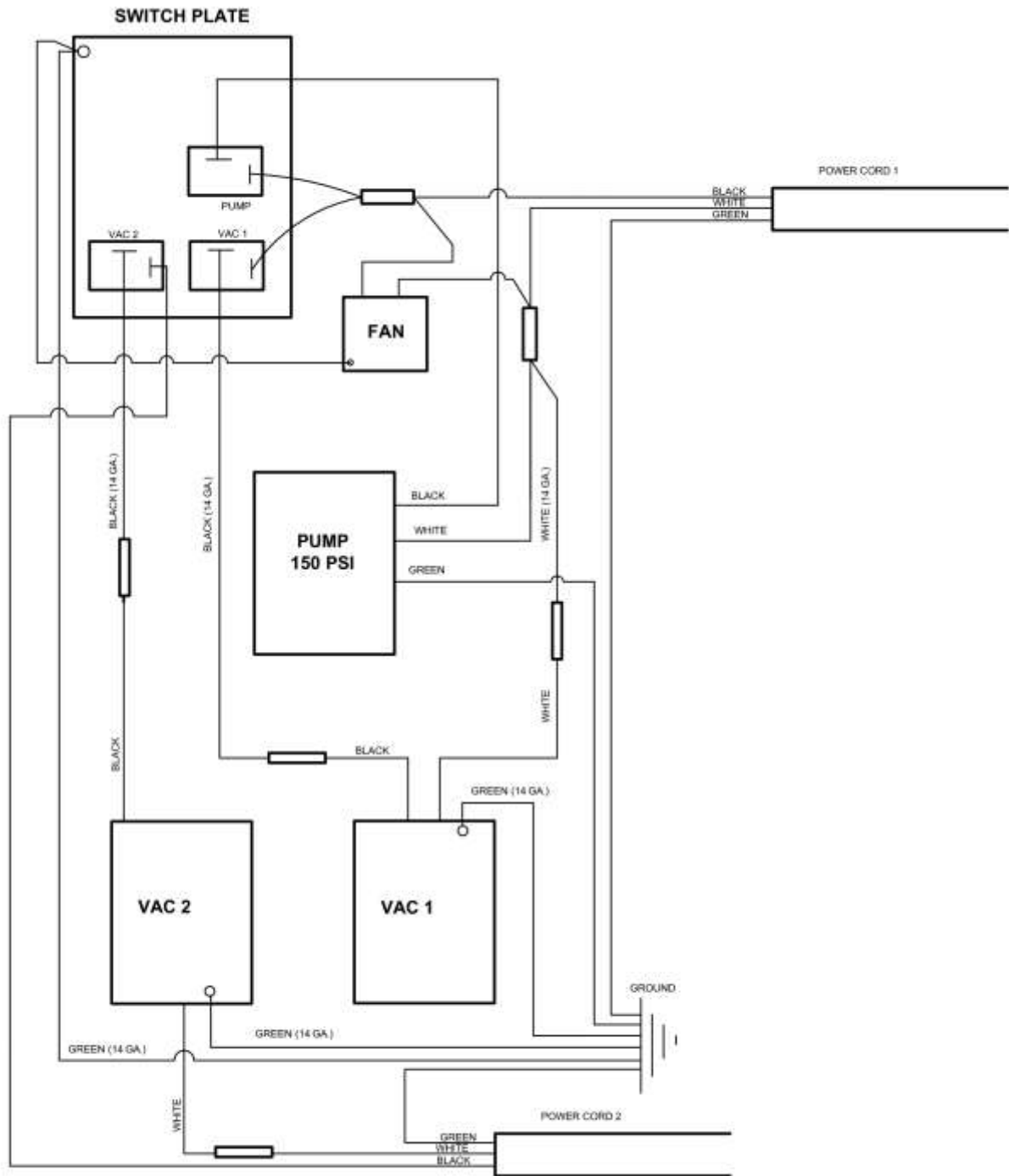

NINJA 150 PSI HEATER MATE WIRING P. 1

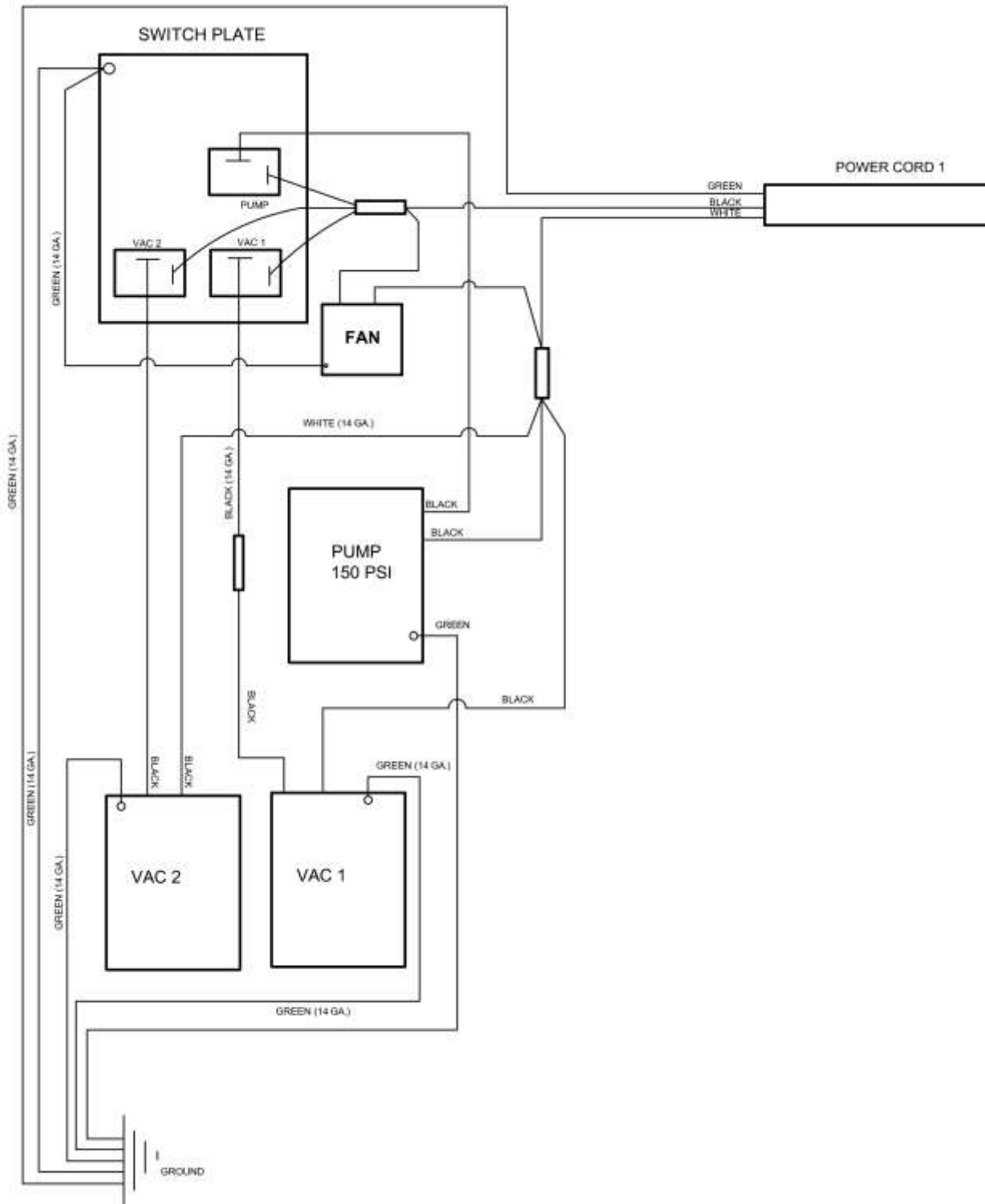

NINJA 150 PSI HEATER MATE WIRING P. 2

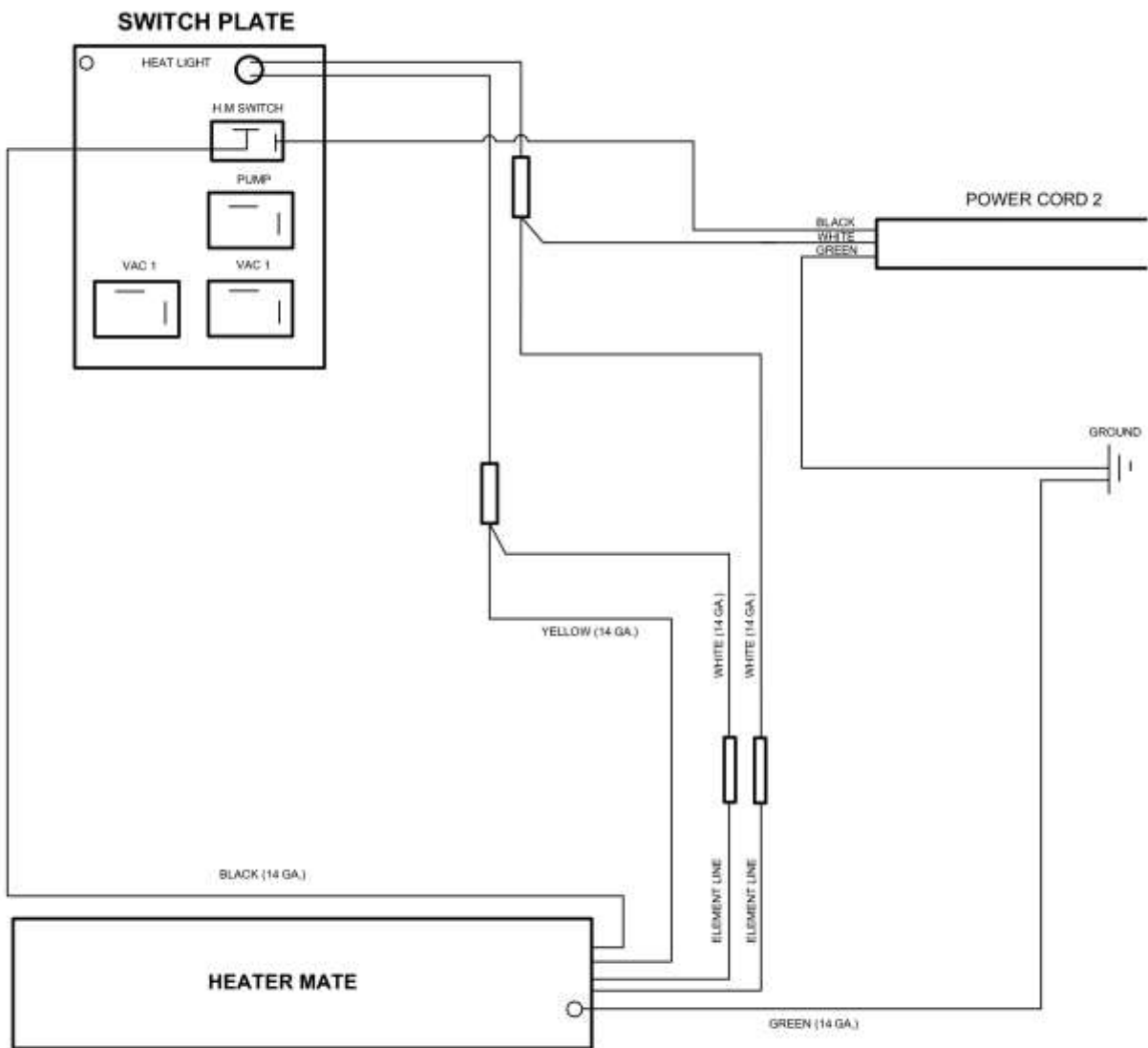

**NINJA 150 MODEL W/ OPTIONAL
CIRCUIT INDICATOR**



CIRCUIT INDICATOR PARTS LIST

REF	PART NO.	DESCRIPTION	NOTES:
1	845-036	Plate	
2	320-111	Lamp	
3	305-057	Relay 120V	
4	305-058	Socket	
5	305-059	Relay 240V	
6	703-108	Decal	
7	465-045	Relay Bracket	

NINJA 150 2-3 STAGE VAC W/ OPTIONAL CIRCUIT INDICATOR WIRING PAGE 1

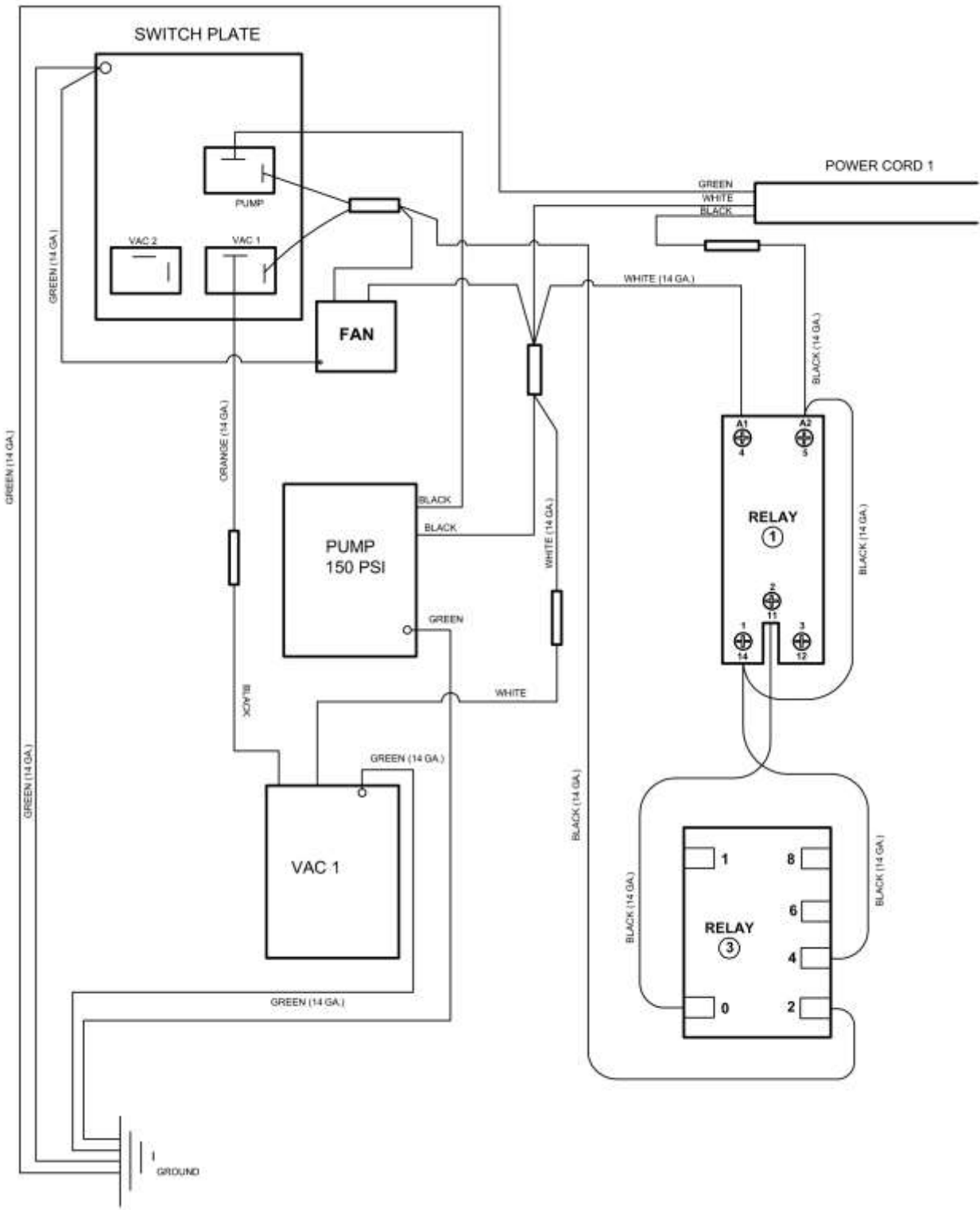

NINJA 150 HEATER MATE W/ OPTIONAL CIRCUIT INDICATOR WIRING PAGE 1

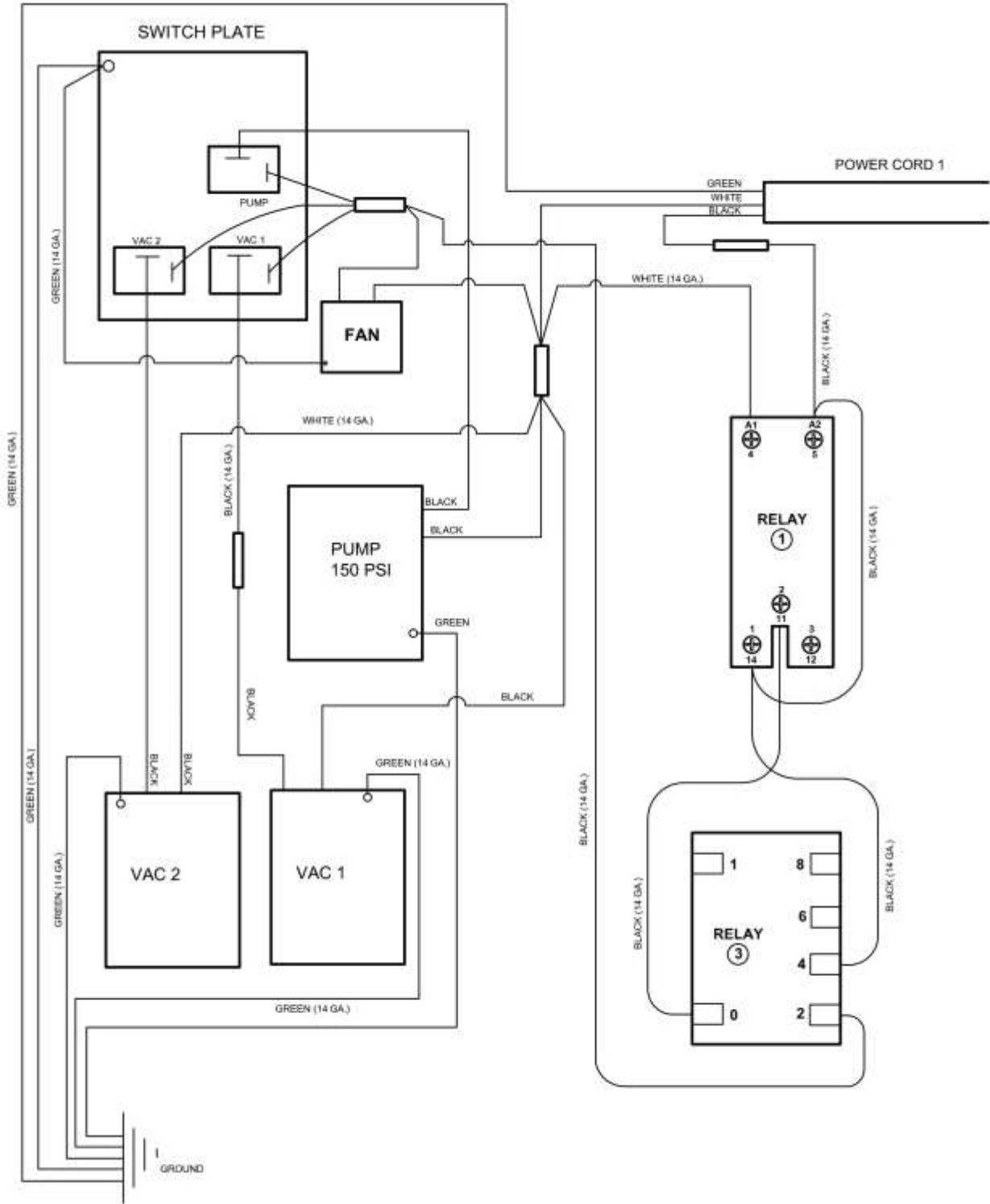

NINJA 150 HEATER MATE W/ OPTIONAL CIRCUIT INDICATOR WIRING PAGE 2

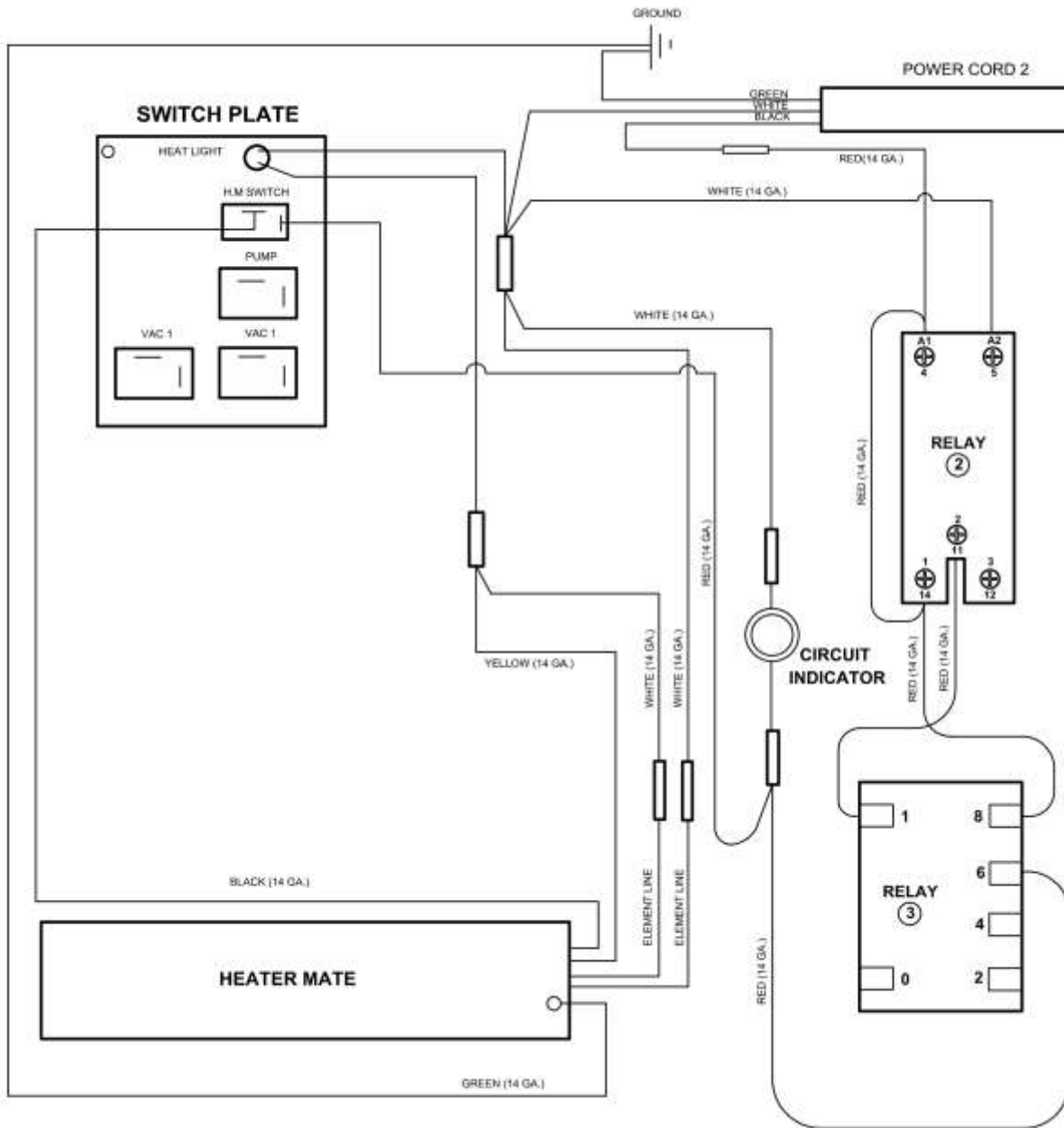



WARRANTY REGISTRATION / DELIVERY ACCEPTANCE

This form must be completed and returned to Esteam Cleaning Systems to activate your warranty.

Esteam would like to take this opportunity to point out a few operating and safety recommendations for your consideration.

* All units cords have a ground plug pin for your safety, never remove or operate any equipment if the ground pin on the plug has been removed.

* Defoamer is to be used in all machines. Improper use of chemicals will void warranty. Drycleaning solvents cannot be used in any Esteam extractors.

* Do not over fill recovery tanks as this will damage the vacuum motors. Vacuum motors showing any signs of moisture contamination will not be covered under warranty.

Model # _____ Serial # _____

Name: _____

Address: _____

City: _____ Province/State: _____

Postal Code/Zip: _____ Date of Purchase: _____
Month / Day / Year

Purchased From: _____

By signing this form I _____, accept the terms and conditions of the warranty.
(print)

I have been fully instructed in the safe operation and use of this equipment.

Signed: _____ Date: _____

Mail Warranty Registration / Delivery Acceptance to:

Esteam Manufacturing Ltd.
3750-19th Street NE
Calgary, Alberta, Canada
T2E 6V2

Or Fax to:
(403) 291 - 0546

ESTEAM® CLEANING SYSTEMS

NINJA EXTRACTOR WARRANTY

NOTICE: REVIEW THIS WARRANTY CAREFULLY AS THIS DOCUMENT CONTAINS LIMITATIONS AND EXCLUSIONS.

PART I:

Esteam Manufacturing Ltd. (hereinafter referred to as "Esteam") warrants each new Ninja Extractor, subject to the limitations as defined in the specific details of its warranty coverage defined below.

LIMITED LIFETIME HOUSING WARRANTY COVERAGE:

Esteam warrants the Ninja Polyethylene Machine Housing Unit to be free from defects in material and workmanship (including cracking, leaking or deterioration) for the life of the unit, expressly subject to the limitations stated herein.

In the event a defect occurs in a Ninja Housing Unit within five years of receipt by the original customer, Esteam will, if satisfied on its examination that the failure is due to defective material or workmanship, repair or replace the Ninja Housing Unit, at no cost to the original customer, other than as maybe provided for in this warranty.

In the event a defect occurs in a Ninja Housing Unit subsequent to five years (and thereafter for life) of receipt by the original customer; Esteam will, if satisfied on its examination, that the failure is due to defective material or workmanship, provide to the original customer only, a new Housing Unit, at 50% of the then published retail pricing basis, used by Esteam.

90 DAY LIMITED WARRANTY COVERAGE:

Esteam warrants all switches, vacuum hoses and solution hoses, heatermate thermostats and thermo cut-outs to be free from defects in material and workmanship, for any defect occurring within 90 days of receipt by the original customer of the Ninja Extractor; and further subject to the limitations stated below. 90 day on labor, subject to Esteam's approval; hourly labor credit is set by Esteam.

12 MONTH WARRANTY COVERAGE:

Subject to the Limited Lifetime Warranty and the 90 Day Limited Warranty; Esteam warrants all remaining items on the Ninja Extractor to be free from defect in material or workmanship (excluding any labour charges) for a period of 12 months from date of receipt of the unit by the original customer; and further subject to the limitations stated below.

PART II - REPLACEMENT PARTS (UNDER WARRANTY)

Replacement warranty parts will be genuine Esteam parts, or parts of similar kind and quality.

All replacement warranty parts are warranted to be free from defects in materials or workmanship from the date of the original unit purchase for the balance of the original warranty period namely: 90 days, 12 months, or the Lifetime, whichever is applicable; all in accordance with the terms of Part I, of this warranty.

PART III - LIMITATIONS ON WARRANTY COVERAGE

WHAT IS NOT COVERED:

Notwithstanding any other term or covenant of Esteam contained herein, the following provisions shall apply:

- (i) No warranty is provided for any Esteam product which has failed as a result of freezing, fire, misuse, alteration, improper amps or voltage, accidental damage, improper maintenance, unauthorized repairs, alterations, abuse, neglect or operation of a Esteam product not expressly recommended or contemplated by Esteam; and
- (ii) No warranty is provided for mechanical or electrical breakdown caused by scale, hard water buildup, improper use of chemicals or resins, damage due to environmental conditions, and acts of God, or other events beyond the control of Esteam; and
- (iii) No warranty is provided for mechanical or electrical breakdown or failure of an Esteam product resulting from ordinary wear and tear, or the consequences thereof; including but not limited to the gradual reduction of the operating performance of the product. The determination of what is or is not ordinary wear and tear is at the sole discretion of Esteam; and
- (iv) No warranty is provided for damage caused by the failure of non-warranted parts and/or accessories, even if warranted parts are damaged as a result of the failure of a non-warranted part; and
- (v) No warranty is provided for damage resulting from failure by the customer to maintain scheduled maintenance requirements. The Esteam system has many parts which must either be replaced or checked for wear on a regular basis; including but not limited to replacement filters and lubricants. This system requires regular maintenance, service and attention by the customer; and
- (vi) No warranty is provided as to any extra expenses incurred by the customer, including but not limited to economic, incidental, consequential loss or damage (e.g. all labour charges, rental equipment, down time, lodging, commercial or business loss of any nature or kind due to product failure); whether direct or indirect, exemplary or punitive damage or loss, and whether in contract, tort or otherwise; and
- (vii) No warranty is provided as to failure of any cosmetic item or finish, labeling, silk screening, decals, paint, trim or other similar decorative items.

- (viii) Brass, rubber and synthetic rubber parts (e.g. "O" rings, diaphragms, gaskets, seals, grommets) are considered expendable in normal use, and are therefore not included in any warranty by Esteam.

PART IV - EXCLUSION OF LIABILITY

Esteam makes no warranties or representations, either expressed or implied, oral or written, in fact, or by operation of law, or otherwise, except as expressly stated herein as to the 90 day Limited, 12 month and Lifetime Extended warranties. Esteam, its officers, directors, agents, dealers and its affiliates (and their respective officers, directors, agents and dealers) shall not be liable to the customer nor to any party for any liability, including without limitation, strict liability, liability for loss, injury or damage due directly or indirectly to the use or operation of the Esteam product; consequential, exemplary and/or punitive damage or loss, whether in contract, tort, or otherwise.

PART V - RETURN GUIDELINES

Defective items must be replaced through a local Esteam Distributor. Replacement parts will be sent via prepaid regular ground service to the distributor. The defective part must be returned F.O.B. factory within 30 days including a letter providing the machine's serial number, date of purchase, material return authorization number, and customer name. If applicable, credit will be issued after the item has been evaluated by Esteam. Failure to comply with return policy will void the warranty on that item.

PART VI - CREDIT POLICY

All customers purchasing parts through an Esteam distributor must arrange credit directly with that distributor.

PART VII - OUTSIDE SOURCE WARRANTY REPAIRS

At the sole discretion of Esteam, it may be necessary to perform warranty/repairs at an outside source. An estimate must be submitted to and approved by Esteam prior to work being performed. Failure to do so will result in denial of your warranty claim.

PART VIII - TRANSFERABILITY

This warranty is not transferable to any subsequent owner.

PART IX - NOTICE - CUSTOMER OBLIGATIONS

- (i) Your responsibility as a customer includes but is not limited to cleaning, lubricating, seasonal maintenance (e.g. winterizing), replacement of worn parts and all regular scheduled or unscheduled maintenance.

- (ii) Any claim for warranty must be presented to Esteam or its authorized dealer, prior to the expiration of the time limitations specified and not thereafter, otherwise any warranty is void.
- (iii) Notwithstanding the generality of the foregoing customer obligations, Esteam does hereby bring to the attention of the customer, these specific maintenance operating requirements of the Ninja Extractor to validate its warranty:

- (a) Chemical Warning:

Any improper use of chemicals shall void any Esteam warranty and thusly exclude any liability by Esteam. No dry cleaning chemical may be used in a Ninja Extractor; - as any such use may result in fire or pump/motor damage. A defoamer solution must be used by customer to limit foaming in the recovery tank.

- (b) Vacuum Motors:

Require use of a defoamer. A vacuum motor showing moisture contamination on interior components shall void any warranty by Esteam.

- (c) Pumps:

All pumps require daily flushing with clean water after use.

- (d) Internal Heatermate:

The internal heater must be flushed with clean water after every use. Any build up of hard water deposits or chemical build up within the internal heater will void any Esteam warranty thusly exclude any liability of Esteam.

The foregoing constitutes Esteam's entire warranty and no other warranty, liability, contingency or responsibility, direct, indirect, consequential or in any other way connected with the sale or operation of Esteam machines or chemical product is expressed or implied.

Ninja Extractor Warranty
Esteam Manufacturing Ltd. 3750-19th Street NE
Calgary, AB T2E 6V2 1-800-653-8338